

Article number: 0102105

Description: Retaining ring J115 DIN472  
Spring steel

## Measures

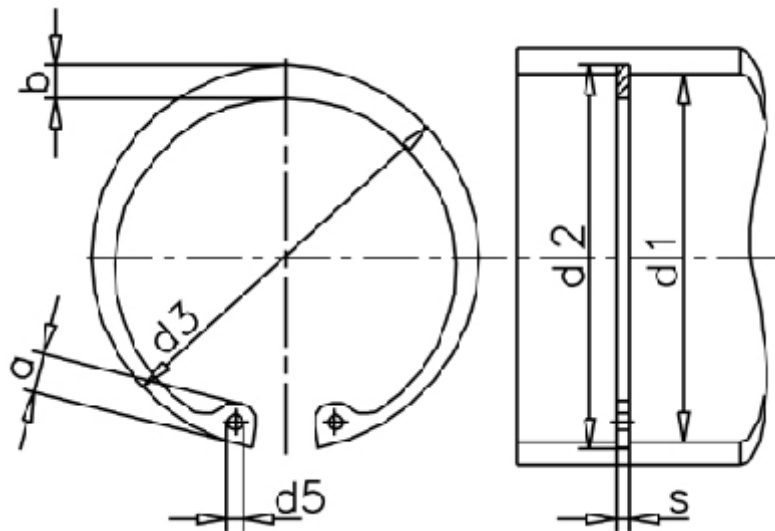

a max	= 10.5	FN kN	= 122.00	t	= 2.00
AN mm <sup>2</sup>	= 735.0	FRg kN	= 71.2	tol	= +0,54
b	= 9.3	FR kN	= 409.0	tol	= +1,50-0,63
d1	= 115	g	= 3.0	tol	= -0.10
d2	= 119.0	K kN-mm	= 829.0	Tong	= ZGJ-4
d3	= 122.00	m min	= 4.15	Weight kg/1000	= 74.50
d5 min	= 3.5	Nominal drive	= 6.0		
Description = J 115		s	= 4.00		